

REVIZYONLAR				
Revizyon	Revizyon Yapan	Revizyon Tarihi	ACIKLAMA	ONAY
Revizyon.1				
Revizyon.2				

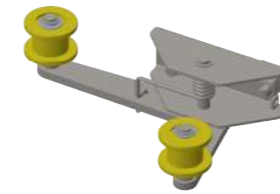

DETAIL C
SCALE 1 : 5

ÖĞE NO.	PARÇA NUMARASI	Tanım	MİKT.
1	VD.K.3000.0073	FORD Şasesi	1
2	VD.K.0100.0007	MOTOR GRUBU	1
3	VD.K.0700.0001	UZUN AYAK GRUBU	1
4	VD.K.0700.0003	Uzun Ayak Grubu FORD 185 mm	1
5	2 300 018 212	KAYIŞ GERDİRME DURUMU	1
6	VD.K.1500.0001	KİLİT ÇEKTİRME KAVRAMA GRUBU	1

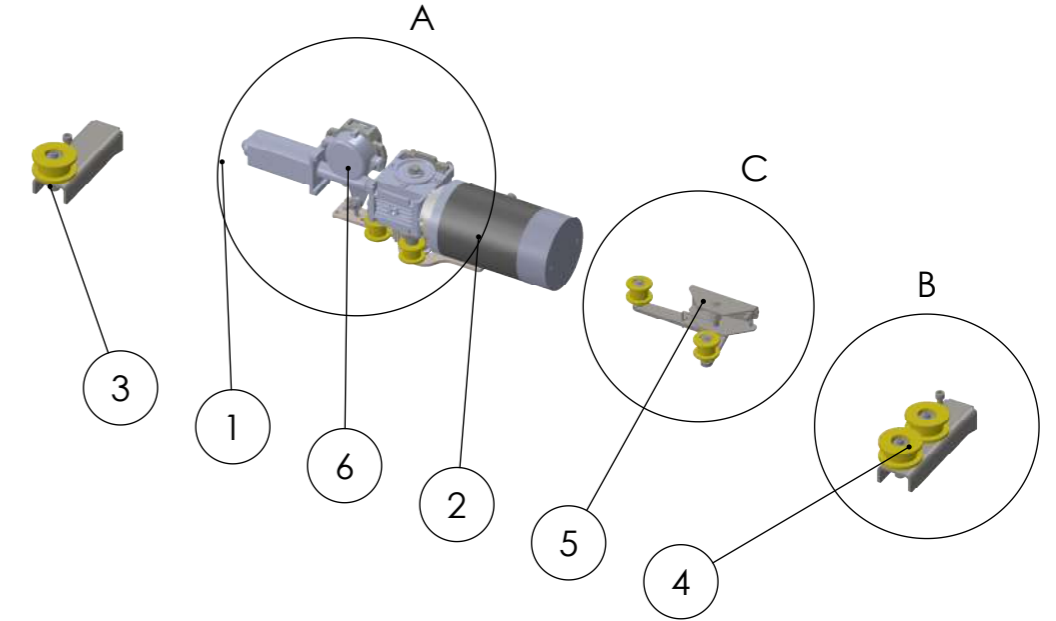
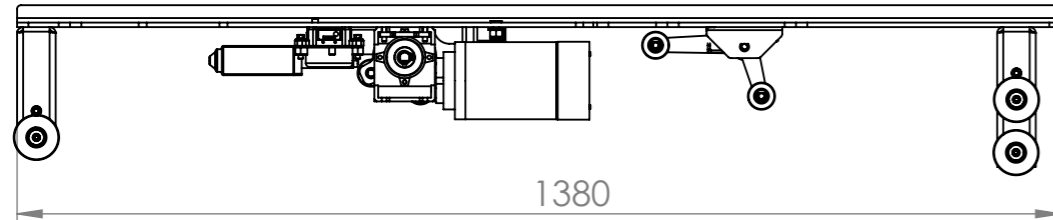
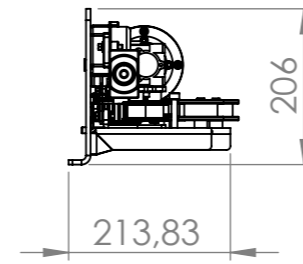
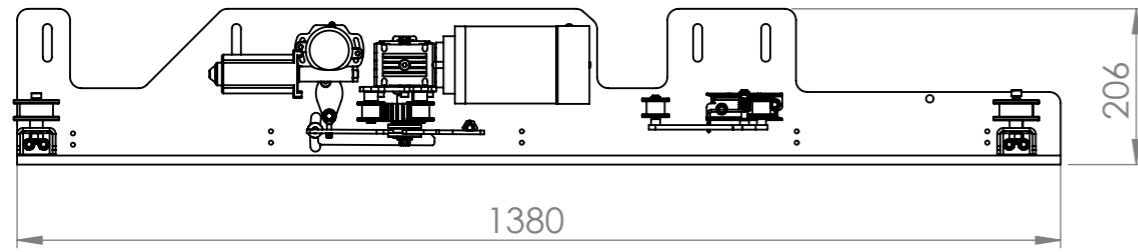
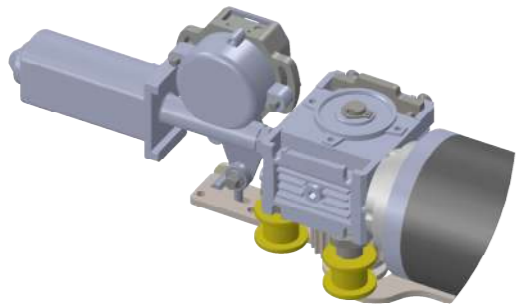

DETAIL A
SCALE 1 : 5

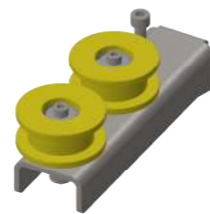

DETAIL B
SCALE 1 : 5

A3		VELDO TEKNOLOJİ			
Cizen	Unvan	Tarih	İmza		
Oğuzhan UÇAR	AR-GE TEKNİKERİ	24.06.2016			
Zafer ÇILĞIN	ATÖLYE ŞEFİ/...../2016			
Tamer KANAT	AR-GE MÜDÜRÜ/...../2016			
Malzeme	Agrılık	Olcek	PARÇA ADI	Ford Şase Grubu	
	6072.31	1/10	PARÇA NO	5 540 230 001	